



COALBROOK

BA1018

WALL MOUNTED 3 HOLE BASIN
MIXER - TRIM

DATE: 07/01/22

REVISION: A

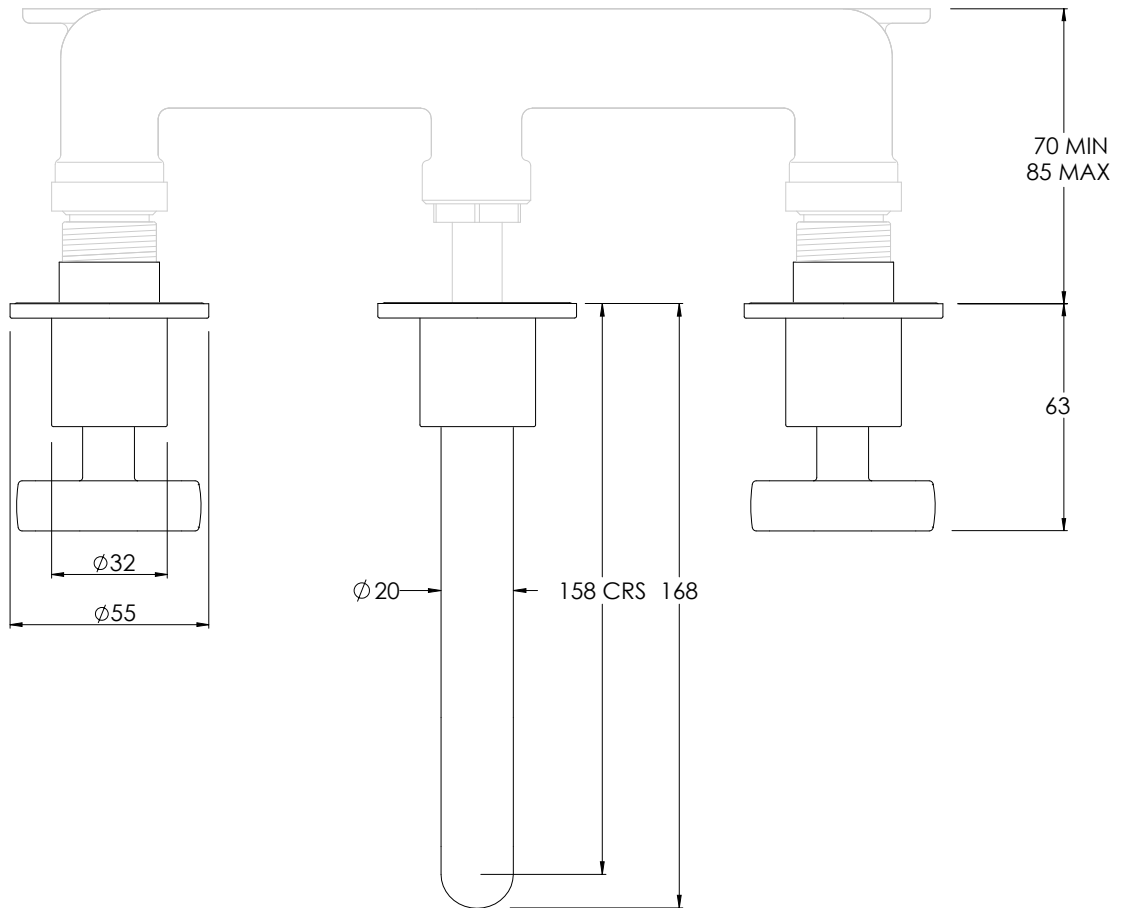
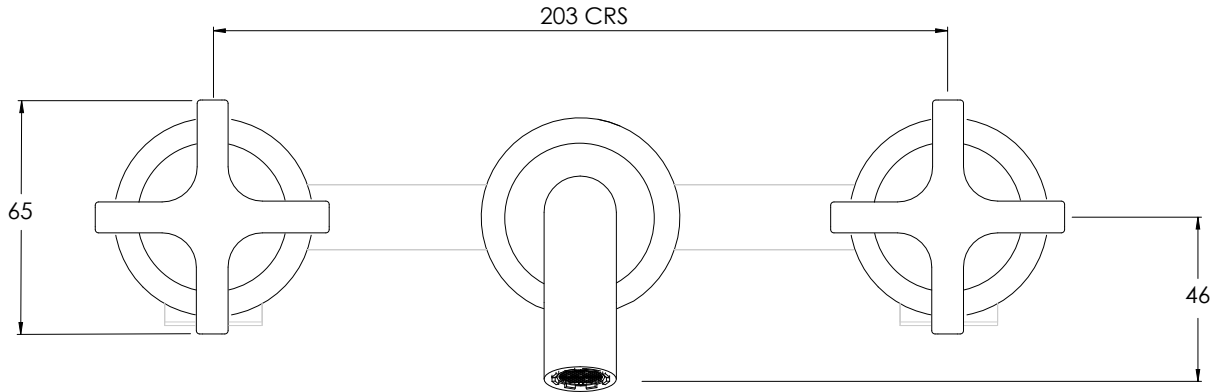

DIMENSIONS IN MILLIMETRES

WHILST EVERY EFFORT IS MADE TO ENSURE THE ACCURACY OF THESE DATA SHEETS THEY ARE SUBJECT TO CHANGE WITHOUT NOTICE AS PART OF THE COMPANY'S PRODUCT DEVELOPMENT PROCESS



COALBROOK

BA1008

WALL MOUNTED 3 HOLE BASIN
MIXER - ROUGH

DATE: 23/11/20

REVISION: A

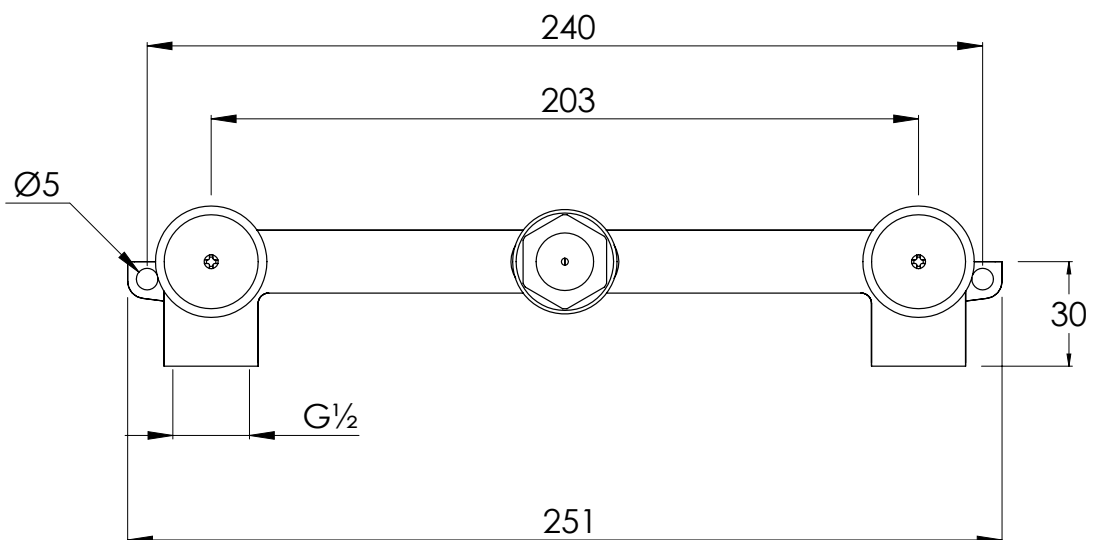
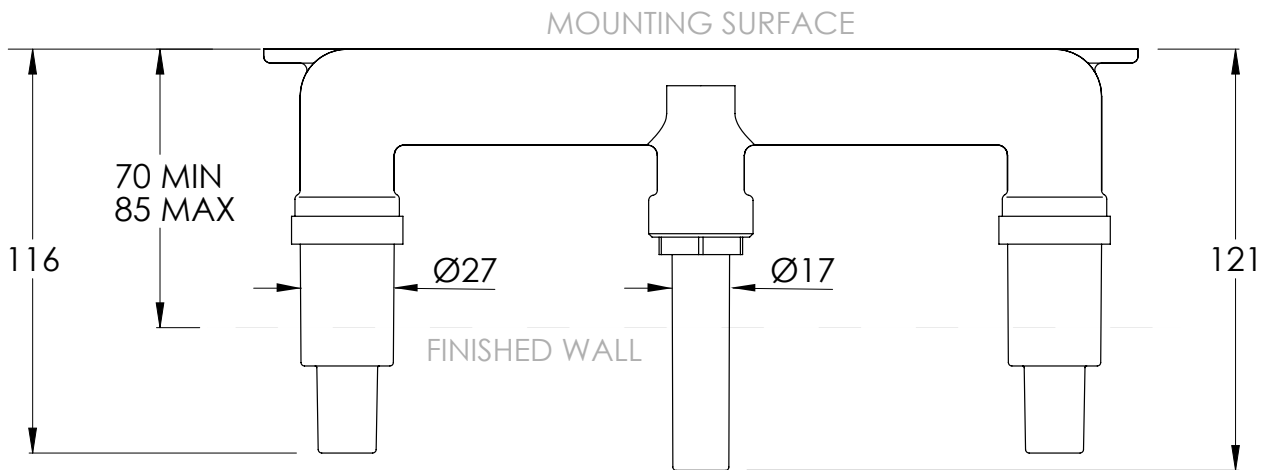

DIMENSIONS IN MILLIMETRES

WHILST EVERY EFFORT IS MADE TO ENSURE THE ACCURACY OF THESE DATA SHEETS THEY ARE SUBJECT TO CHANGE WITHOUT NOTICE AS PART OF THE COMPANY'S PRODUCT DEVELOPMENT PROCESS